

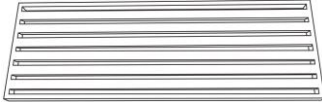

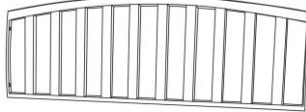

Assembly Instructions

4' Steel Park Bench w/ Vertical Slats

Before assembly, be sure that all components are included.

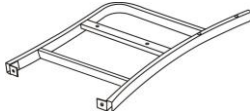
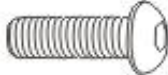
Part List	Description	Qty.	Drawings
A	Seat Panel	1	
B	Backrest	1	
C1	Left Armrest	1	
C2	Right Armrest	1	
D	Bolt (M8x25)	4	
E	Bolt (M8x35)	4	
F	Allen Wrench	1	

Tool required: Allen Wrench (Provided)



Special Warnings

- The bench is made to sit on four legs, do not tilt back on two legs as it may result in injury or damage.
- The bench is made to sit on solid ground, make sure not to place on soft ground as it may result in injury or damage.
- Inspect before every use; do not use if parts are loose or damaged.
- This product is not a toy. Do not allow children to play with or on this item.

Assembly Steps:

- Step # 1:** Place all parts on a clean surface. Attach Seat Panel (A) to the Left Armrest (C1) and Right Armrest (C2) by using Bolts (E). **Hand tighten!**

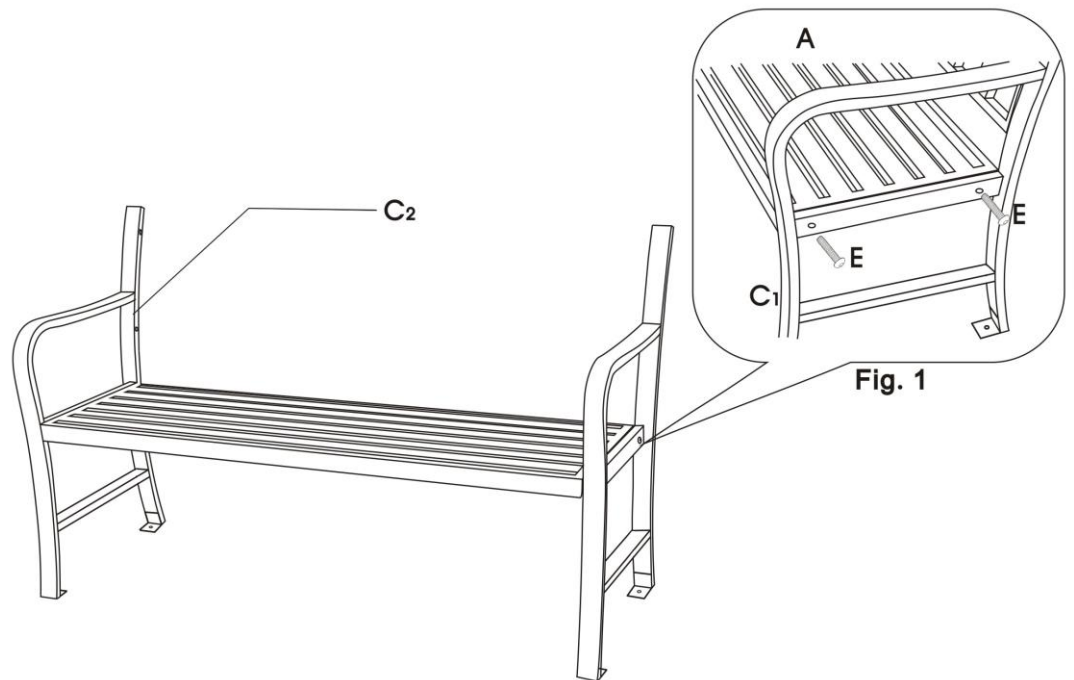

Step # 2: Attach the Backrest (B) to the Left Armrest (C1) and Right Armrest (C2) by using Bolts (D). **Hand tighten!** Adjust the bench to a level position and tighten all the Bolts with Allen Wrench (F) (Provided).

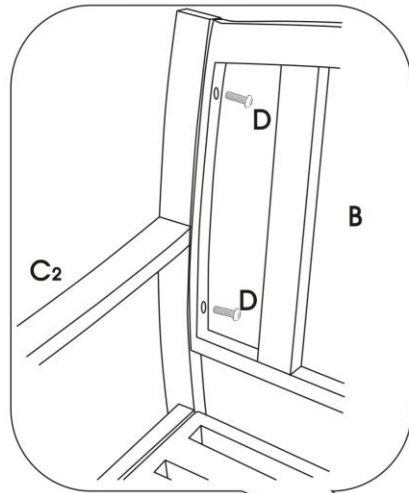

Fig. 2

