

SPECIFICATIONS

BC1750
REV #2 1/3/2019

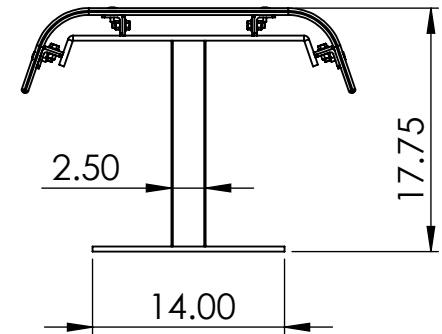
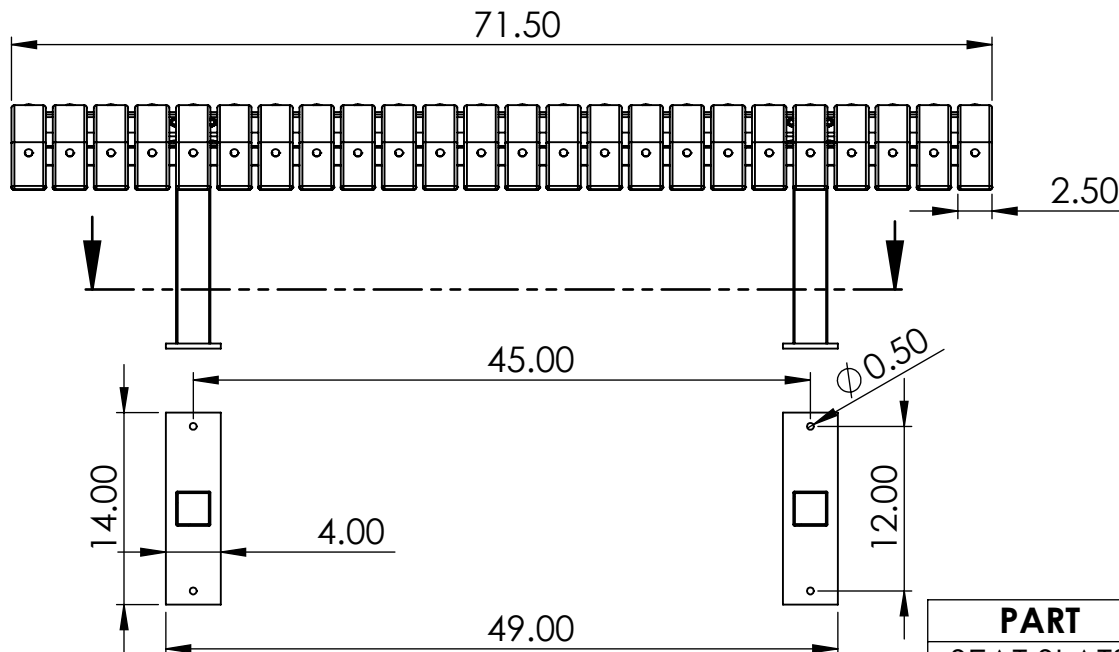
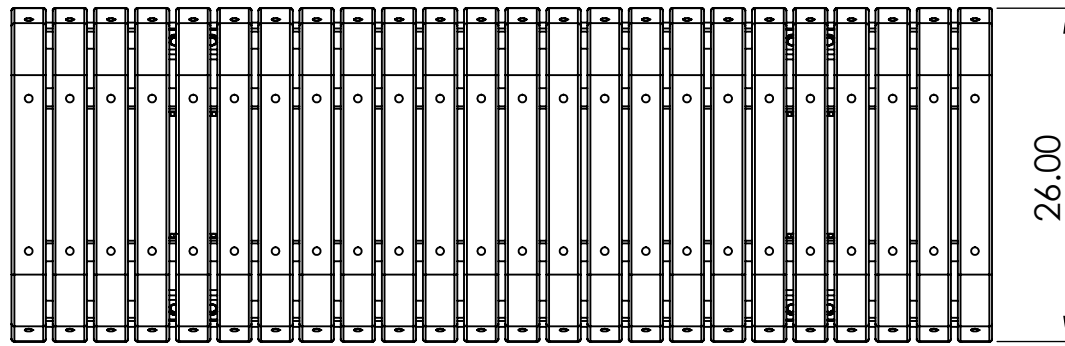
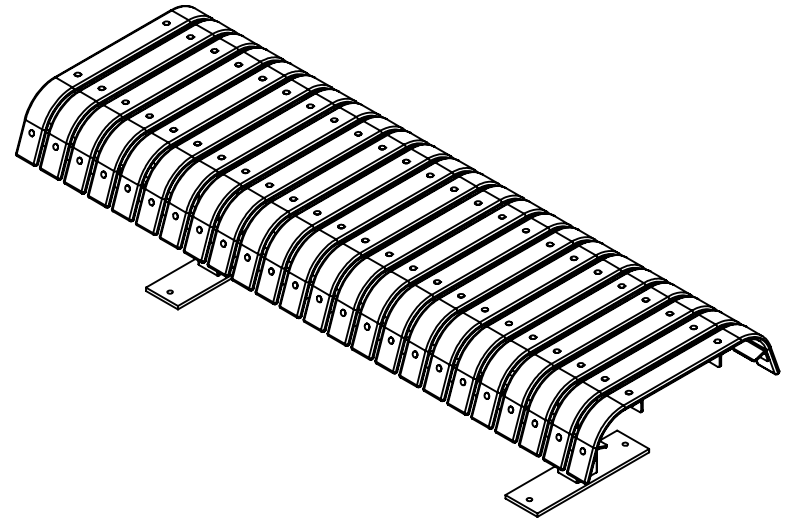

ALL DIMENSIONS SHOWN IN INCHES

PART	PART NUMBER	QTY	MATERIAL
SEAT SLATS	ABC-P0100	24	ReHDPE
RIVETS	RVT-ABC1700	96	ALUMINUM
BENCH ENDS	SS11700-SM	2	POWDER COATED STEEL
ANGLE IRON	SS11700	4	POWDER COATED STEEL